

UP

— STAIRLIFT —

WE WILL CHANGE
YOUR WAY UP





WE ARE CHANGING YOUR WAY UP...

In design, technology, knowledge, and life, enjoy your independence at home with confidence and ease – longer.

Change your way UP and over your obstacles, hurdles, or mountains.

UP Stairlift.

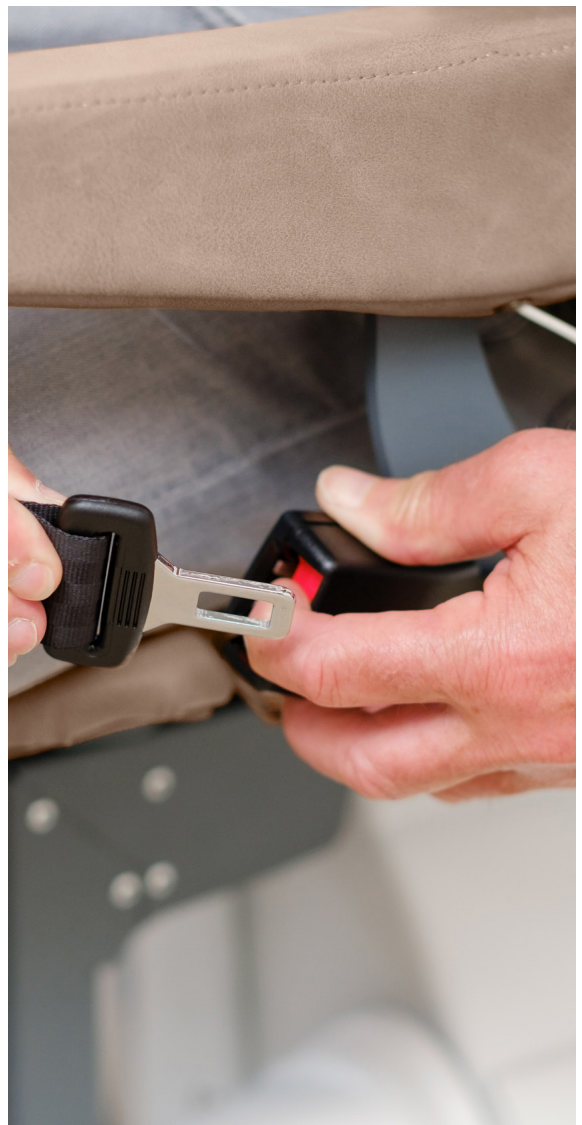

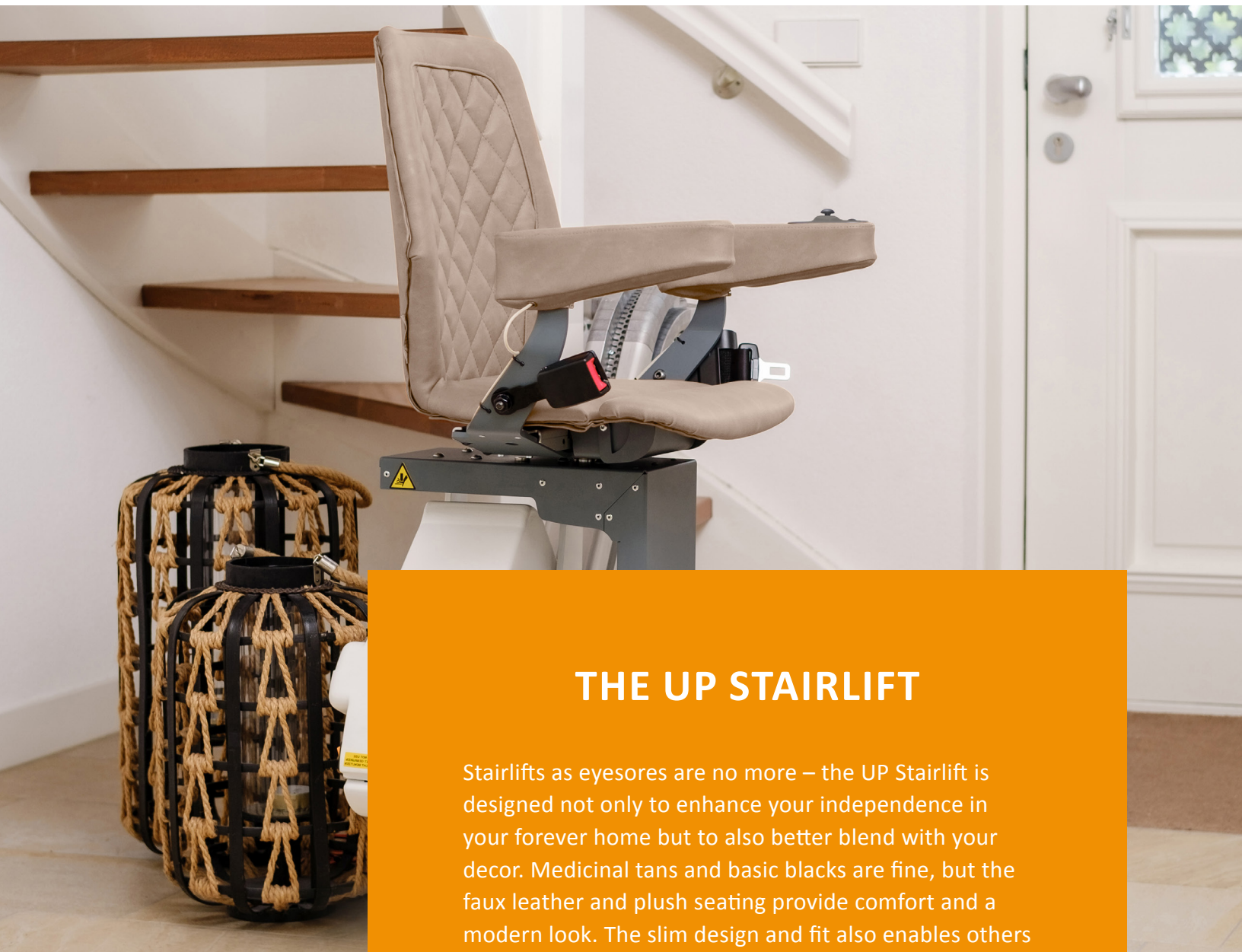

THE UP STAIRLIFT

Stairlifts as eyesores are no more – the UP Stairlift is designed not only to enhance your independence in your forever home but to also better blend with your decor. Medicinal tans and basic blacks are fine, but the faux leather and plush seating provide comfort and a modern look. The slim design and fit also enables others in the household to easily pass through the staircase. Level UP all around with the UP Stairlift!

If the time comes to move or your no longer need a stairlift, don't worry – the UP Stairlift's modular design makes it so it can be removed from the stairs and reconfigured and reused in another home. All rail parts can be converted into a new shape and, if necessary, can be combined with new rail segments – an environmentally friendly way to change your way UP.

MODULAR RAIL

The UP Stairlift's rail system consists of two parts: extruded recycled aluminum rail sections and bends. This way, no matter the shape of your stairs, there is almost always a solution available for your home! It also allows for quick, nearly-next-day installations so you can get UP that mountain in no time. Enjoy the rapid turnaround, narrow profile, and all-around safer home lifestyle!

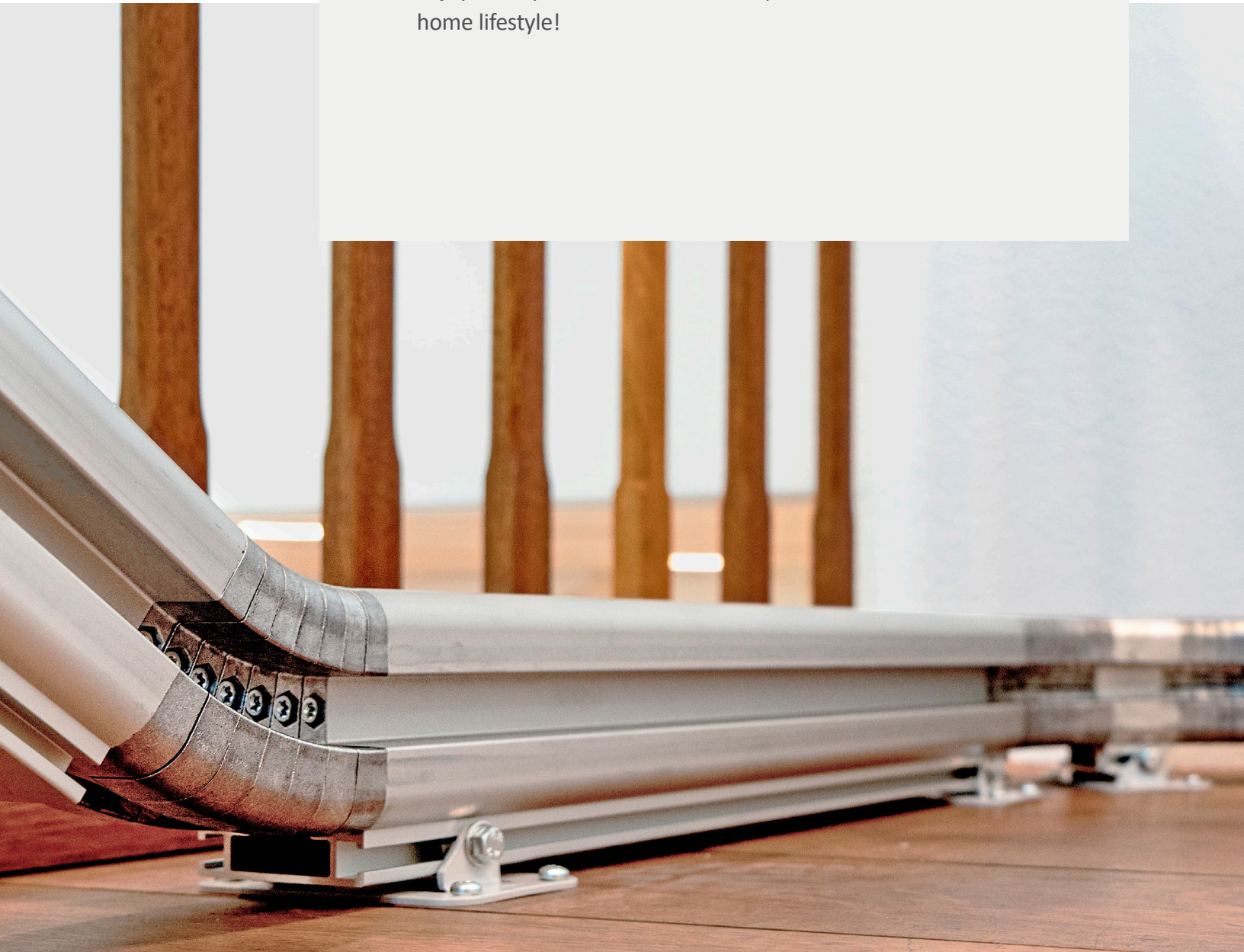

ALWAYS INCLUDED



FOLDABLE ARMRESTS

Fold the armrests to easily and safely get on and off the stairlift seat. When finished using the lift, leave them folded for more usable space on the stairs!



POWERED SWIVEL SEAT

To get on and off the chair safely, the seat automatically turns from the stairs to the upstairs or downstairs landings.



POWERED (UN)-FOLDING FOOTREST

Bending over is no longer necessary, the footrest will automatically (un)fold when you put the armrests up or down.

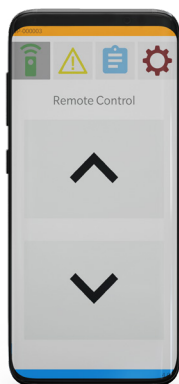

REMOTE APP

With the use of an application on your smartphone or tablet, it is possible to move the chair up- and downstairs. With the app you can also lock the lift for use if children are in the house and share diagnostics with your local dealer. This allows most challenges to be solved remotely.



**THE UP STAIRLIFT
HAS A MODERN DESIGN
AND DIAMOND STITCHED
UPHOLSTERY**





LANDING OPTIONS

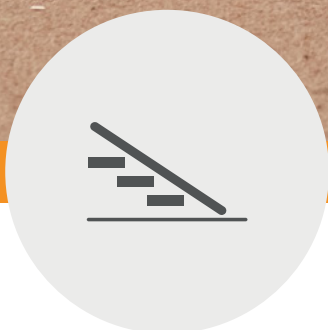

STRAIGHT

The basic finish with a straight rail ending. The stairlift parks at the end of the stairs and no bends are needed for this landing option.

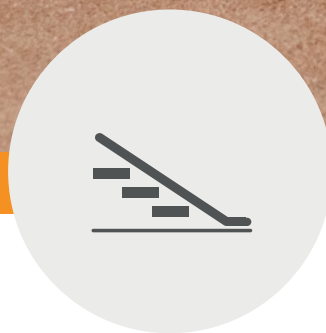

HORIZONTAL

Park the stairlift on a horizontal end piece. This is a great option when you prefer to keep the seat further away from the stairs which makes your stairs more spacious.

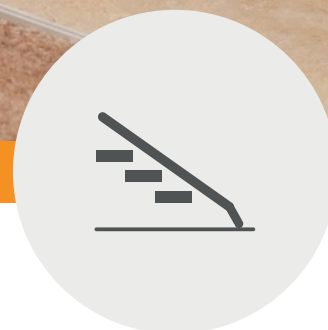

DROPTNOSE

This option provides the most free space when the lift is not in use. In this case, the seat is only 160mm / 6- $\frac{3}{16}$ inch from the riser.

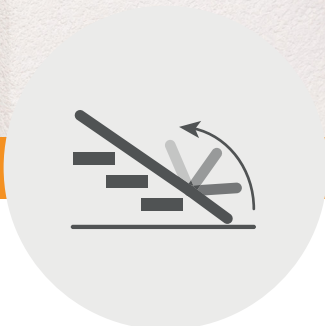

POWERED HINGE RAIL

In the event the rail may block a doorway or walkway, the powered hinge rail is a great choice to keep the path clear when the lift is not in use.



PARKING CURVE 90 DEGREES

With the 90 degrees parking curve, the stairlift can be parked just around the corner from the bottom or top of the staircase. This convenient feature saves space and is easily created due to the modular rail design.



PARKING CURVE 180 DEGREES

Save even more space with the 180-degree parking curve. Park your stairlift along the back of the staircase or on the opposite side of the staircase wall! Curves can be made easily due to the modular rail.

GOING UP - STRAIGHT FINISH

UP Stairlifts are also compatible with straight staircases. This option also offers the choice of a hinge rail or footrest-level finish. The straight UP Stairlift choice also boasts included features such as the powered swivel seat, powered folding footrest, and intercom.

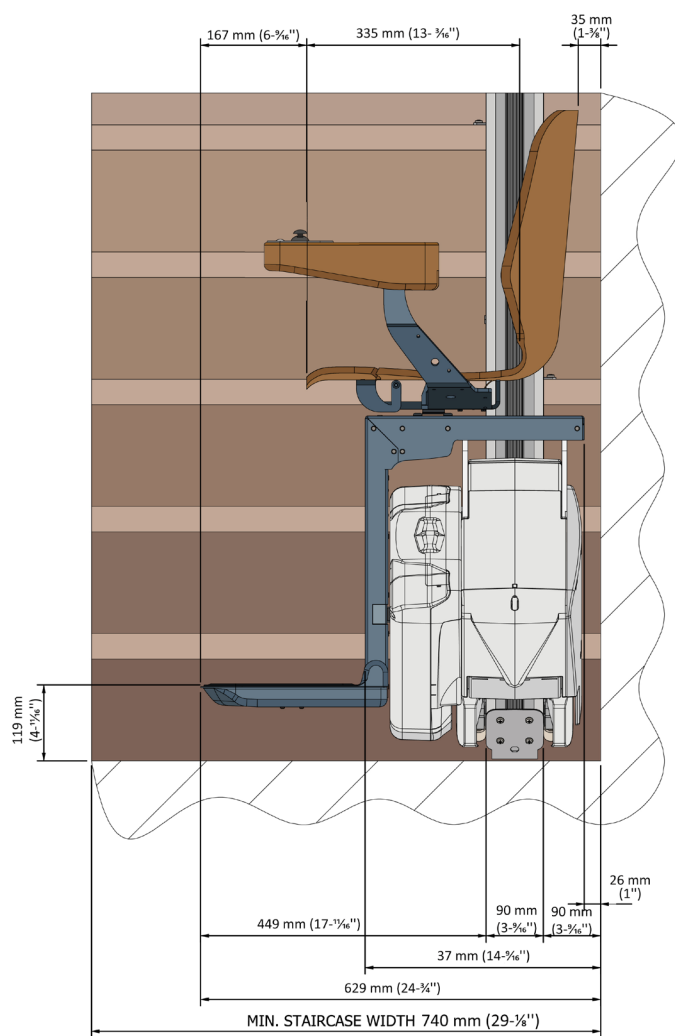
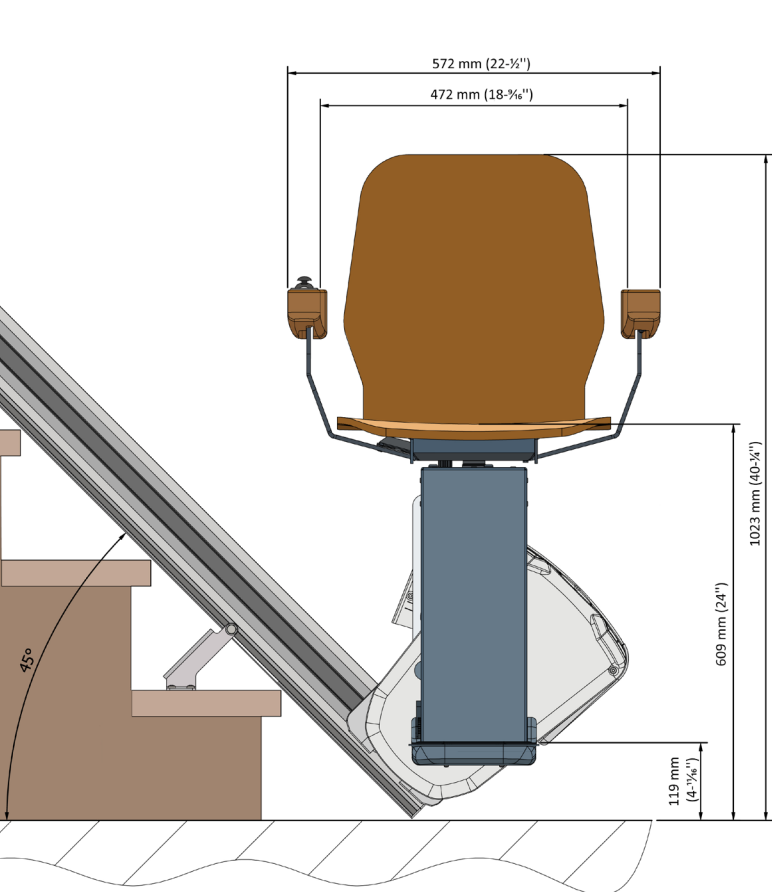

GOING UP - OVERRUN FINISH

If your staircase has one or more bend, curve, sweep, or landing, the modular curved rail would be best for your unique staircase. These lifts also include the powered swivel seat, powered folding footrest, and intercom.

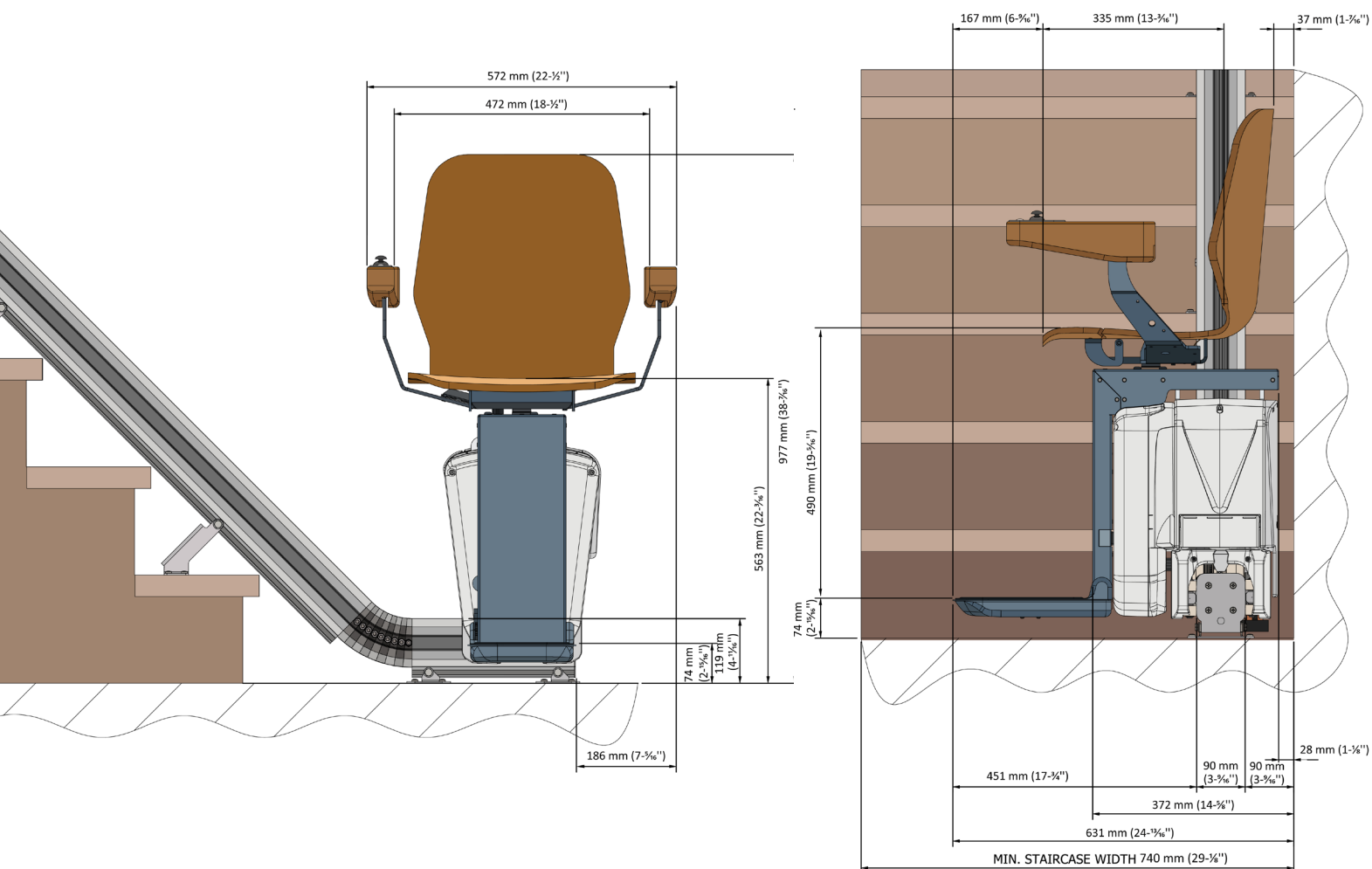

SPECIFICATIONS

Weight Capacity	- 275 lb
Speed	- up to 29.5 FPM
Folds	- 15.5"
Drive	- Rack and pinion
Power Source	- 24V DC (battery)
Incline Limit	- 15° to 70° - 70° drop nose / reduced lower intrusion
Track Length	- up to 62'
Certified	- CSA B355-19 - CSA B44.1/ASME A17.5-2019 - ASME A18.1-2020 - Rated residential - Indoor use only
Features	- 60° power swivel seat at top and bottom landings - Powered folding footrest - Retractable seat belt and sensor - Constant pressure controls - 2 Joystick remote controls - Android App remote - Overspeed governor brake - Chassis and footrest obstruction sensors - Remote Wi-Fi diagnostic
Option	- Powered hinge rail



CONTROL THE UP STAIRLIFT

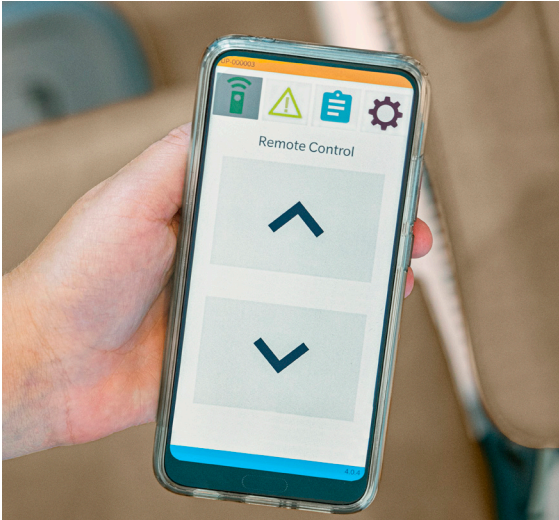

REMOTE APP

If you have an Android phone, the UP Stairlift can also be called/sent using the UP Stairlift app!



JOYSTICK

The stairlift is usually operated with the joystick on the armrest. No complicated levers and buttons, just turn the joystick to the right or left.



REMOTE CONTROL

If there are multiple stairlift users in the home, you may need to call or send the chair if it's not at the correct landing. Use the remote control included with your stairlift to control your seat without having to ride it.

ENVIRONMENTALLY FRIENDLY

Social responsibility is paramount in the development and production of the UP Stairlift. The stairlift is produced in the Netherlands and the choice to use an aluminium rail provides enormous savings in energy and CO2 emission. Aluminium is a durable, lightweight and sustainable material, and aluminium's characteristics help ensure the rail will last for generations.



Should the rail get exhausted after years of loyal service, then it will still remain 100% recyclable.

RECYCLED ALUMINIUM

Also, the aluminium used for our rail is produced by the most energy-efficient extruder in the world. Norway-based, the company produces products with a 70% hydro-energy ratio and more commonly uses recycled aluminium. By recycling aluminium, approximately 80 tons of greenhouse gasses are saved, which is equivalent to 15 million vehicles on the road.



NO USE OF HEAVY CHEMICALS

Aluminum also does not corrode - most other stairlift rails require a powder coating to slow down corrosion.

FULLY REUSABLE

Sustainable manufacturing and reusable products are of great importance. Our unique rail design supports this circular process. Not only can the chair be preserved, but the rail can as well. All rail parts are fully reusable and can be converted to a new shape and be combined with new rail elements. The UP Stairlift can be re-installed in your new home if moving or reused in another home when you no longer need a stairlift.



YOUR ADVANTAGES



NEXT DAY DELIVERY

Measured and installed within one day



REUSABLE

The modular rail fits on virtually every staircase



ALWAYS INCLUDED

Intercom, automatic swivel chair and footrest



REMOTE DIAGNOSTICS

Can solve challenges remotely



MODERN DESIGN

Fits in any interior



REMOTE APP

Operate your lift through your Android!



SUSTAINABLE

100% recyclable

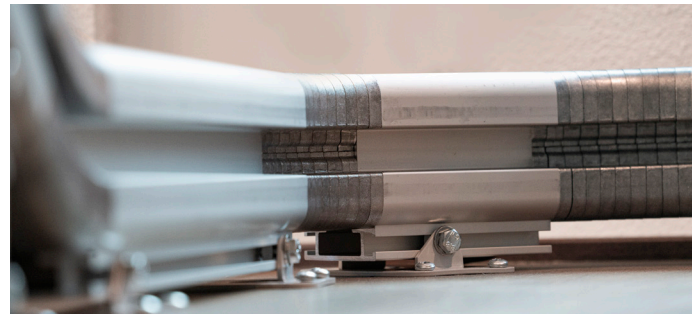



CONTACT

The UP Stairlift is available through Harmar's extensive dealer network. For any questions, information in general or ordering your UP Stairlift, please contact your local UP-dealer. Contact us or check our website to find and contact a dealer closest to you.

✉ UP@harmar.com

YOUR UP-DEALER:

